



Qubino



Product catalogue

- [Page 2 | Flush Dimmer \(Z-Wave Plus\)](#)
- [Page 3 | Flush Dimmer 0-10V \(Z-Wave Plus\)](#)
- [Page 4 | DIN Dimmer \(Z-Wave Plus\)](#)
- [Page 5 | Flush 1 Relay \(Z-Wave Plus\)](#)
- [Page 6 | Flush 1D Relay \(Z-Wave Plus\)](#)
- [Page 7 | Flush 2 Relays \(Z-Wave Plus\)](#)
- [Page 8 | Flush Shutter \(Z-Wave Plus\)](#)
- [Page 9 | Flush Shutter DC \(Z-Wave Plus\)](#)
- [Page 10 | Smart Meter \(Z-Wave Plus\)](#)
- [Page 11 | Smart Meter Accessories](#)
- [Page 12 | Weather Station \(Z-Wave Plus\)](#)
- [Page 13 | Flush On/Off Thermostat](#)
- [Page 14 | Flush Heat & Cool Thermostat](#)
- [Page 15 | Flush PWM Thermostat](#)
- [Page 16 - 18 | Accessories List](#)

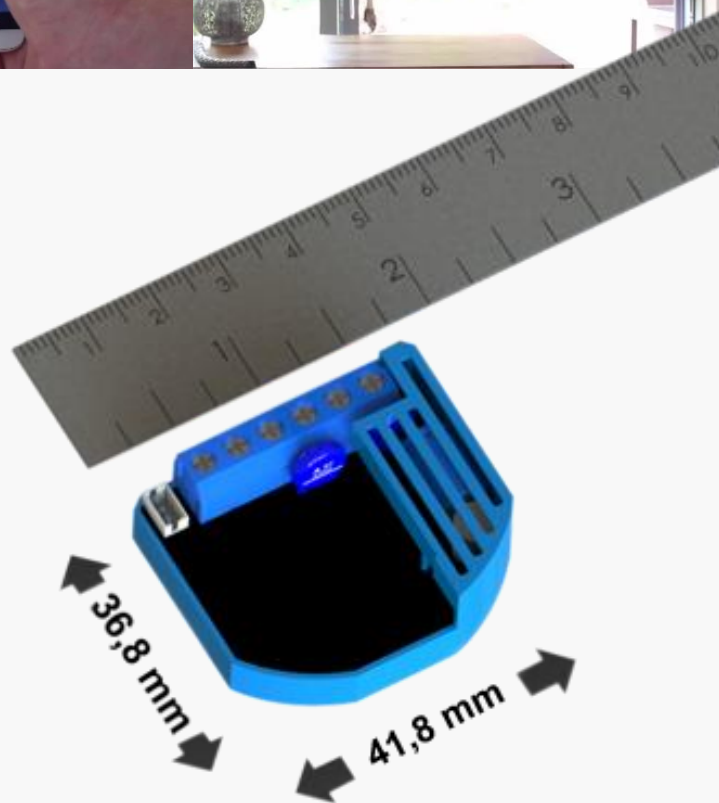



Flush Dimmer

ORDERING CODE	Z-WAVE FREQUENCY	COUNTRY/REGION
ZMNHDD1	868.4 MHz	CEPT, China, Singapore, South Africa, UAE
ZMNHDD2	921.4 MHz	Australia, Brazil, New Zealand
ZMNHDD3	908.4 MHz	Chile, Mexico, USA/Canada
ZMNHDD4	869.0 MHz	Russia

This module is used for dimming the light or to manage the speed of a fan. The module can be controlled either through a Z-Wave network or through the wall switch. The module is designed to be mounted inside a “flush mounting box” and is hidden behind a traditional wall switch.

Wiring diagram

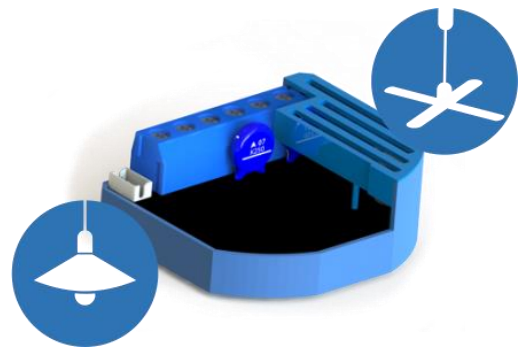
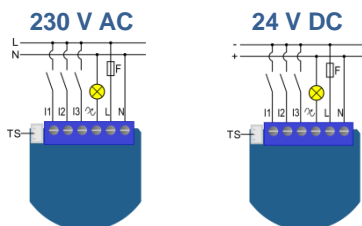

ADVANTAGES

The first (**MOSFET switching**) dimming module in the world which also supports control of:

- low voltage halogen lamps with electronic transformer,
- dimmable compact fluorescent light.

The smallest dimming module in the world.

Special designed casing ensure the most simplified installation (ease of cabling fixing) inside a flush mounting box.

PROVED and TESTED BY PROFESSIONAL ELECTRICIANS! Extremely **low energy consumption**: less than 0.7 W.

Extended operating temperatures: (-10 to 40) °C.

Support for the connection of **digital temperature sensor**. **Power consumption measurement**.

2 binary inputs offer the option to connect additional devices such as sensors, switches/push buttons, etc.



TECHNICAL DATA

Power supply	(110 to 230) V AC ± 10 % 50/60Hz, (24 to 30) V DC
Rated load current of AC output	0.6 A/230 V AC
Rated load current of DC output	0.85 A/30 V DC
Output circuit power of AC output (resistive load)	140 W (230 V AC)
Output circuit power of DC output (resistive load)	21 W (24 V DC)
Power monitoring accuracy	± 2 W
Frequency Range	868.4 MHz, 921.4 MHz, 908.4 MHz, 869.0 MHz, Z-Wave
Digital temperature sensor range (sensor must be ordered separately)	(-50 to 125) °C
Operation temperature	(-10 to 40) °C
Distance	up to 30 m indoors
Dimensions (W x H x D)	41.8 mm x 36.8 mm x 15.4mm
Package dimensions (W x H x D)	79 mm x 52 mm x 22mm
Weight	28 g
Gross weight (packaging included)	34 g
Electricity consumption	0.7 W
For installation in boxes	Ø ≥ 60 mm or 2M
Switching	MOSFET (Trailing edge)

Additional information is available in the technical specifications.

PACKAGE CONTAINS

1 module and 1 User manual





Flush Dimmer 0-10V

ORDERING CODE	Z-WAVE FREQUENCY	COUNTRY/REGION
ZMNHVD1	868.4 MHz	CEPT, China, Singapore, South Africa, UAE
ZMNHVD2	921.4 MHz	Australia, Brazil, New Zealand
ZMNHVD3	908.4 MHz	Chile, Mexico, USA/Canada
ZMNHVD4	869.0 MHz	Russia

Dimmer 0-10V module is used for dimming lights, fan speed regulation and control of any other device with 0-10V input control.

Module has a standard 0-10V output and a multi-function input, which may be a push button / switch, a potentiometer or 0-10V signal.



Wiring diagram

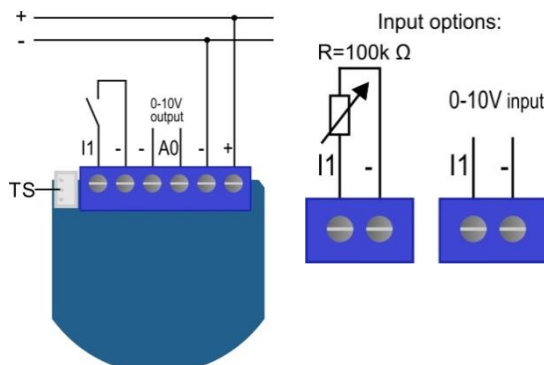

ADVANTAGES

- Standard **(0-10) V OUTPUT** and a multi-function input, which can be a:
 - push button / switch / potentiometer / (0-10) V signal
- **INPUT (0-10) V** (any sensor with (0-10) V output)
- Perfect for **dimming lights with ballast (0 to 10) V**
- **Controlling fan speed** (for motors or frequency inverters with (0-10) V speed control input)
- **Controlling heating/cooling valves** (with (0-10) V input)

TECHNICAL DATA

Power supply	(12 to 24) V DC
Max. sinking control voltage	(- 20 / +20) V DC
Max. sourcing control voltage	(0 to 11) V DC
Max. sinking current	2 mA
Max. sourcing current	10 mA
Digital temperature sensor range (sensor must be ordered separately)	(-50 to +125) °C
Operation temperature	(-10 to 40) °C
Distance	up to 30 m indoors
Dimensions (W x H x D) (package)	41.8 mm x 36.8 mm x 15.4 mm (79 mm x 52 mm x 22 mm)
Weight (Gross with package)	28 g (34 g)
Electricity consumption	0.5 W

Additional information is available in the technical specifications.

PACKAGE CONTAINS

1 module and 1 User manual





DIN Dimmer

ORDERING CODE	Z-WAVE FREQUENCY	COUNTRY/REGION
ZMNHSD1	868.4 MHz	CEPT, China, Singapore, South Africa, UAE
ZMNHSD2	921.4 MHz	Australia, Brazil, New Zealand
ZMNHSD3	908.4 MHz	Chile, Mexico, USA/Canada
ZMNHSD4	869.0 MHz	Russia

This Z-Wave module is used for dimming the bulb or to manage the speed of a fan. The module can be controlled either through a Z-Wave network or through the wall switch. The module is designed to be mounted inside an electrical cabinet onto DIN rail.

Module measures power consumption of bulb or fan and supports connection of digital temperature sensor. It is designed to act as repeater in order to improve range and stability of Z-wave network.



Wiring diagram

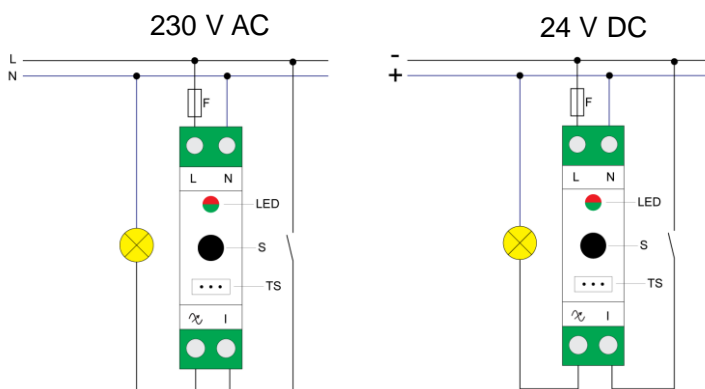

ADVANTAGES

(MOSFET switching) dimming module in the world which also supports control of:

low voltage halogen lamps with electronic transformer, dimmable compact fluorescent light.

Dimming loads: (1 to 200) W

Easy installation The module is designed to be mounted inside an electrical cabinet onto DIN rail.

Extremely low energy consumption: less than 0.7 W.

Extended operating temperatures: (-10 to 40) °C.

Support for the connection of **digital temperature sensor**.

Power consumption measurement integrated

TECHNICAL DATA

Power supply	(110 to 230) V AC \pm 10 % 50/60 Hz, (24 to 30) V DC
Rated load current of AC output	0.85 A/230 V AC
Rated load current of DC output	0,85 A/30 V DC
Output circuit power of AC output (resistive load)	200 W (230 V AC)
Output circuit power of DC output (resistive load)	21 W (24 V DC)
Power monitoring accuracy	\pm 2 W
Digital temperature sensor range (sensor must be ordered separately)	(-50 to 125) °C
Operation temperature	(-10 to 40) °C
Distance	up to 30 m indoors
Dimensions (W x H x D)	18 mm x 93 mm x 58 mm
Package dimensions (W x H x D)	21 mm x 95 mm x 64 mm
Weight	50 g
Gross weight (packaging included)	56 g
Electricity consumption	0.7 W
For installation in boxes	DIN rail 35 mm
Switching	MOSFET (Trailing edge)



PACKAGE CONTAINS

1 module and 1 User manual





Flush 1 Relay

ORDERING CODE	Z-WAVE FREQUENCY	COUNTRY/REGION
ZMNHAD1	868.4 MHz	CEPT, China, Singapore, South Africa, UAE
ZMNHAD2	921.4 MHz	Australia, Brazil, New Zealand
ZMNHAD3	908.4 MHz	Chile, Mexico, USA/Canada
ZMNHAD4	869.0 MHz	Russia

This module is used for switching On or Off the electrical device (e.g. light, fan, etc.). The module can be controlled either through a Z-Wave network or through the wall switch. The module is designed to be mounted inside a “flush mounting box” and is hidden behind a traditional wall switch.

Wiring diagram

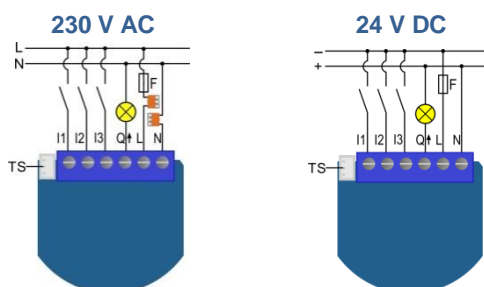

ADVANTAGES

OMRON relay used for switching ensure long durability and top quality.

The smallest 1 relay module in the world.

Special designed casing ensure the most simplified installation (ease of cabling fixing) inside a flush mounting box. **PROVED and TESTED BY PROFESSIONAL ELECTRICIANS !**

Extremely **low energy consumption**: less than 0.4 W.

Extended operating temperatures: (-10 to 40) °C.

Support for the connection of **digital temperature sensor**.

Power consumption measurement.

2 binary inputs offer the option to connect additional devices such as sensors, switches/push buttons, etc.

TECHNICAL DATA

Power supply	(110 to 230) V AC \pm 10 % 50/60Hz, (24 to 30) V DC
Rated load current of AC output (resistive load)	1 X 10 A/230 V AC
Rated load current of DC output (resistive load)	1 X 10 A/30 V DC
Output circuit power of AC output (resistive load)	2300 W (230 V AC)
Output circuit power of DC output (resistive load)	240 W (24 V DC)
Power monitoring accuracy	P= (5 to 50) W, \pm 3 W; P>50 W, \pm 3 %
Frequency Range	868.4 MHz, 921.4 MHz, 908.4 MHz, 869.0 MHz, Z-Wave
Digital temperature sensor range (sensor must be ordered separately)	(-50 to 125) °C
Operation temperature	(-10 to 40) °C
Distance	up to 30 m indoors
Dimensions (W x H x D)	41.8 mm x 36.8 mm x 15.4 mm
Package dimensions (W x H x D)	79 mm x 52 mm x 22 mm
Weight	28 g
Gross weight (packaging included)	34 g
Electricity consumption	0.4 W
For installation in boxes	$\varnothing \geq$ 60 mm or 2M
Switching	Relay

Additional information is available in the technical specifications.

PACKAGE CONTAINS

1 module and 1 User manual





Flush 1D Relay

ORDERING CODE	Z-WAVE FREQUENCY	COUNTRY/REGION
ZMNHND1	868.4 MHz	CEPT, China, Singapore, South Africa, UAE
ZMNHND2	921.4 MHz	Australia, Brazil, New Zealand
ZMNHND3	908.4 MHz	Chile, Mexico, USA/Canada
ZMNHND4	869.0 MHz	Russia

This module is used for switching On or Off the electrical device (e.g. light, fan, etc.). Output contact is voltage free (dry contact), so also loads with different power supply can be connected to the module.

The module can be controlled either through a Z-Wave network or through the wall switch. The module is designed to be mounted inside a "flush mounting box" and is hidden behind a traditional wall switch.



Wiring diagram

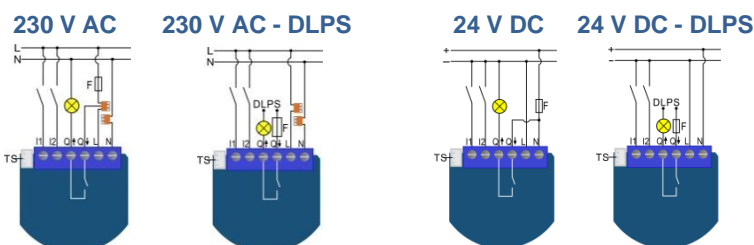

ADVANTAGES



Dry contact – voltage free

OMRON relay used for switching ensure long durability and top quality.

The smallest 1 relay module in the world.

Special designed casing ensure the most simplified installation (ease of cabling fixing) inside a flush mounting box. **PROVED and TESTED BY PROFESSIONAL ELECTRICIANS !**

Extremely low energy consumption: less than 0.4 W.

Extended operating temperatures: (-10 to 40) °C.

Support for the connection of **digital temperature sensor**.

2 binary inputs offer the option to connect additional devices such as sensors, switches/push buttons, etc.

TECHNICAL DATA

Power supply	(110 to 230) V AC \pm 10% 50/60Hz, (24 to 30) V DC
Rated load current of AC output (resistive load)	1 X 10 A/230 V AC
Rated load current of DC output (resistive load)	1 X 10 A/30 V DC
Output circuit power of AC output (resistive load)	2300 W (230 V AC)
Output circuit power of DC output (resistive load)	240 W (24 V DC)
Frequency Range	868.4 MHz, 921.4 MHz, 908.4 MHz, 869.0 MHz, Z-Wave
Digital temperature sensor range (sensor must be ordered separately)	(-50 to 125) °C
Operation temperature	(-10 to 40) °C
Distance	up to 30 m indoors
Dimensions (W x H x D)	41.8 mm x 36.8 mm x 15.4 mm
Package dimensions (W x H x D)	79 mm x 52 mm x 22mm
Weight	28 g
Gross weight (packaging included)	34 g
Electricity consumption	0.4 W
For installation in boxes	$\varnothing \geq 60$ mm or 2M
Switching	Relay

Additional information is available in the technical specifications.

PACKAGE CONTAINS

1 module and 1 User manual





Flush 2 Relays

ORDERING CODE	Z-WAVE FREQUENCY	COUNTRY/REGION
ZMNHBD1	868.4 MHz	CEPT, China, Singapore, South Africa, UAE
ZMNHBD2	921.4 MHz	Australia, Brazil, New Zealand
ZMNHBD3	908.4 MHz	Chile, Mexico, USA/Canada
ZMNHBD4	869.0 MHz	Russia

This module is used for switching On or Off two electrical devices (e.g. lights, fans, etc.). The module can be controlled either through a Z-Wave network or through the wall switches. The module is designed to be mounted inside a “flush mounting box” and is hidden behind a traditional wall switch.



Wiring diagram

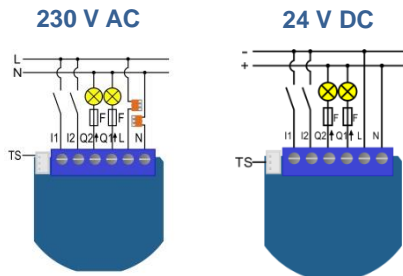

ADVANTAGES

- OMRON relays** used for switching ensure long durability and top quality.
- The smallest 2 relays** module in the world.
- Special designed casing** ensure the most simplified installation (ease of cabling fixing) inside a flush mounting box. **PROVED and TESTED BY PROFESSIONAL ELECTRICIANS !**
- Extremely low energy consumption:** less than 0.4 W.
- Extended operating temperatures:** (-10 to 40) °C.
- Support for the connection of **digital temperature sensor**.
- Power consumption measurement.**

TECHNICAL DATA

Power supply	(110 to 230) V AC ± 10 % 50/60Hz, (24 to 30) V DC
Rated load current of AC output (resistive load)	2 X 4 A/230 V AC
Rated load current of DC output (resistive load)	2 X 4 A/30 V DC
Output circuit power of AC output (resistive load)	2 X 920 W (230 V AC)
Output circuit power of DC output (resistive load)	2 X 96 W (24 V DC)
Power monitoring accuracy	P= (0 to 200) W, ± 2 W; P>200 W, ± 3 %
Frequency Range	868.4 MHz, 921.4 MHz, 908.4 MHz, 869.0 MHz, Z-Wave
Digital temperature sensor range (sensor must be ordered separately)	(-50 to 125) °C
Operation temperature	(-10 to 40) °C
Distance	up to 30 m indoors
Dimensions (W x H x D)	41.8 mm x 36.8 mm x 16.9 mm
Package dimensions (W x H x D)	79 mm x 52 mm x 22 mm
Weight	28 g
Gross weight (packaging included)	34 g
Electricity consumption	0.4 W
For installation in boxes	∅ ≥ 60 mm or 2M
Switching	Relay (2x)

Additional information is available in the technical specifications.

PACKAGE CONTAINS

1 module and 1 User manual





Flush Shutter

ORDERING CODE	Z-WAVE FREQUENCY	COUNTRY/REGION
ZMNHCD1	868.4 MHz	CEPT, China, Singapore, South Africa, UAE
ZMNHCD2	921.4 MHz	Australia, Brazil, New Zealand
ZMNHCD3	908.4 MHz	Chile, Mexico, USA/Canada
ZMNHCD4	869.0 MHz	Russia

This module is used to control the motor of blinds, rollers, shades, venetian blinds, windows, etc. It also supports venetian blind slats tilting and it can be controlled either through a Z-Wave network or through the wall switch. Precise positioning is supported for motors equipped with mechanical or electronic end limit switches.

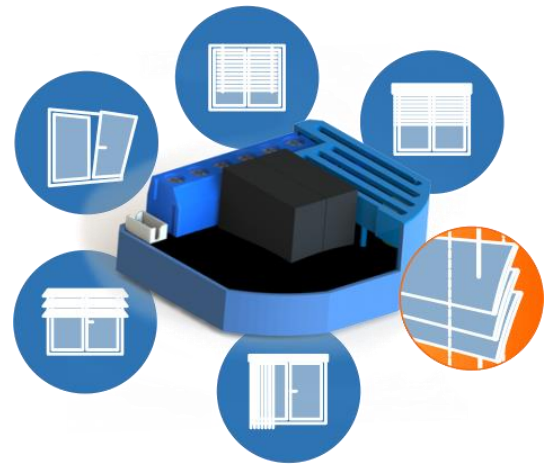

Wiring diagram for 230 V AC

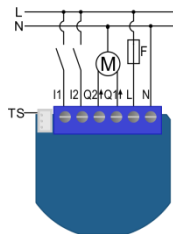

ADVANTAGES

Support venetian blind slats tilting

OMRON relays used for switching ensure long durability and top quality.

The smallest blinds control module in the world.

Special designed casing ensure the most simplified installation (ease of cabling fixing) inside a flush mounting box. **PROVED and TESTED BY PROFESSIONAL ELECTRICIANS !**

Extremely **low energy consumption**: less than 0.4 W.

Extended operating temperatures: (-10 to 40) °C.

Support for **precise positioning**.

Support for the connection of **digital temperature sensor**.

Power consumption measurement.

TECHNICAL DATA

Power supply	(110 to 230) V AC $\pm 10\%$ 50/60Hz, (24 to 30) V DC
Rated load current of AC output (resistive load)	2 X 4 A/230 V AC
Rated load current of DC output (resistive load)	2 X 4 A/30 V DC
Output circuit power of AC output (resistive load)	2 X 920 W (230 V AC)
Output circuit power of DC output (resistive load)	2 X 96 W (24 V DC)
Power monitoring accuracy	P= (0 to 200) W, $\pm 2\%$; P>200 W, $\pm 3\%$
Frequency Range	868.4 MHz, 921.4 MHz, 908.4 MHz, 869.0 MHz, Z-Wave
Digital temperature sensor range (sensor must be ordered separately)	(-50 to 125) °C
Operation temperature	(-10 to 40) °C
Distance	up to 30 m indoors
Dimensions (W x H x D)	41.8 mm x 36.8 mm x 16.9 mm
Package dimensions (W x H x D)	79 mm x 52 mm x 22 mm
Weight	28 g
Gross weight (packaging included)	34 g
Electricity consumption	0.4 W
For installation in boxes	$\varnothing \geq 60$ mm or 2M
Switching	Relay (2x)

Additional information is available in the technical specifications.

PACKAGE CONTAINS

1 module and 1 User manual





Flush Shutter DC

ORDERING CODE	Z-WAVE FREQUENCY	COUNTRY/REGION
ZMNHOD1	868.4 MHz	CEPT, China, Singapore, South Africa, UAE
ZMNHOD2	921.4 MHz	Australia, Brazil, New Zealand
ZMNHOD3	908.4 MHz	Chile, Mexico, USA/Canada
ZMNHOD4	869.0 MHz	Russia

This module is used to control the (12 to 24) V DC motor of blinds, rollers, shades, venetian blinds, windows, etc. It also supports venetian blind slats tilting and it can be controlled either through a Z-Wave network or through the wall switch. Precise positioning is supported for motors equipped with mechanical or electronic end limit switches.

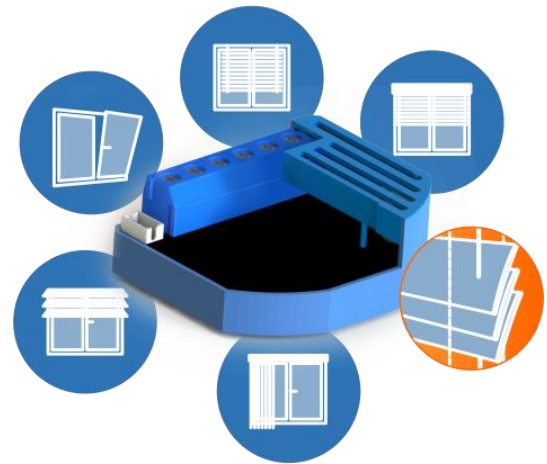

Wiring diagram for (12 to 24) V DC

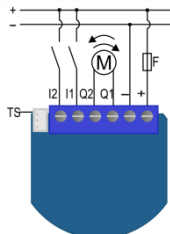

ADVANTAGES

- Support venetian blind slats tilting.**
- Protection** against accidental short circuit on outputs.
- Protection** against wrong power supply connection.
- Over temperature** protection.
- The smallest** blinds control module in the world.
- Special designed casing** ensure the most simplified installation (ease of cabling fixing) inside a flush mounting box. **PROVED and TESTED BY PROFESSIONAL ELECTRICIANS !**
- Extremely **low energy consumption**: cca. 0.3 W.
- Extended operating temperatures**: (-10 to 40) °C.
- Support for **precise positioning**.
- Support for the connection of **digital temperature sensor**.
- Power consumption measurement.**

TECHNICAL DATA

Power supply	(12 to 24) V DC ±10 %
Rated load current of DC output (resistive load)	2 A
Overcurrent protection	6 A
Output circuit power of DC output (resistive load)	48 W
Power monitoring accuracy	± 5 %
Frequency Range	868.4 MHz, 921.4 MHz, 908.4 MHz, 869.0 MHz, Z-Wave
Digital temperature sensor range (sensor must be ordered separately)	(-50 to 125) °C
Operation temperature	(-10 to 40) °C
Distance	up to 30 m indoors
Dimensions (W x H x D)	41.8 mm x 36.8 mm x 15.4 mm
Package dimensions (W x H x D)	79 mm x 52 mm x 22 mm
Weight	28 g
Gross weight (packaging included)	34 g
Electricity consumption	cca. 0.3W
For installation in boxes	∅ ≥ 60 mm or 2M
Switching	H bridge

Additional information is available in the technical specifications.

PACKAGE CONTAINS

1 module and 1 User manual





Smart Meter

ORDERING CODE	Z-WAVE FREQUENCY	COUNTRY/REGION
ZMNHTD1	868.4 MHz	CEPT, China, Singapore, South Africa, UAE
ZMNHTD2	921.4 MHz	Australia, Brazil, New Zealand
ZMNHTD3	908.4 MHz	Chile, Mexico, USA/Canada
ZMNHTD4	869.0 MHz	Russia

This Z-Wave module is used for energy measurements in single-phase electrical power network up to 65 A. Meters measure energy directly in 2-wire networks according to the principle of fast sampling of voltage and current signals. A built-in microprocessor calculates energy, power and power factor from the measured signals.

The module can be controlled through Z-wave network and it acts as repeater in order to improve range and stability of Z-wave network. It is designed to be mounted on DIN rail.



ADVANTAGES

- Measurement up to 65A** (single phase)
- Easy installation** (DIN rain mounting)
- Switching control (ON/OFF) 2x32A** (with IKA and BICOM)

Wiring diagram

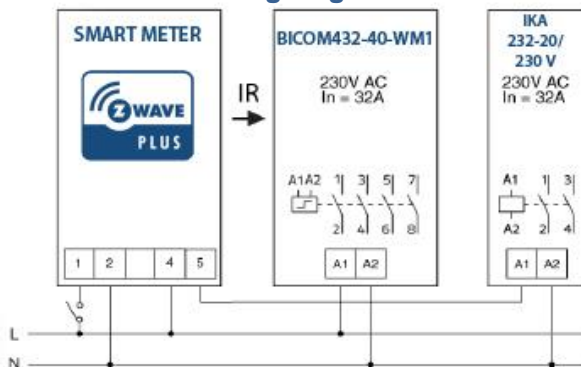

The module can control two electrical devices (switching on/off):

- one BICOM432-40-WM1 Bistable switch (32 A) controlled by built in optical (IR) communication port and
- one IKA232-20/230 V Contactor (32 A) controlled by output on terminal 5.

Additional information for bistable switch and contactor is available in Smart Meter accessories.

PACKAGE CONTAINS

1 module and 1 User manual



TECHNICAL DATA

Main terminals (LI, NI, Lo, No)	
Contacts capacity	(1.5 to 16 (25)) mm ²
Connection screws	M5
Max torque	3.5 Nm (PZ2)
Optional terminals (1,2,4,5)	
Contact capacity	(0.05 to 1 (2.5)) mm ²
Screws	M3
Max torque	0.6 Nm
Measuring input	
Type (connection)	single phase (1b)
Reference current (Iref)	5 A
Maximum current (Imax)	65 A
Minimum current (Imin)	0.25 A
Starting current	20 mA
Voltage (Un)	230 V (± 20 %)
Power consumption at Un	< 2 W
Nominal frequency (fn)	50 and 60 Hz
Accuracy	
Active energy and power	
Standard EN 62053-21	class 1
Standard EN 50470-3	class B
Reactive energy	
Standard EN 62053-23	Class 2
Optical communication	
Type	IR - used to control BICOM432-40-WM1
Input (1)	
Rated voltage	230 V (± 20 %)
Input resistance	450 kOhm
Safety	
Indoor meter	Yes
Degree of pollution	2
Protection class	II
AC voltage test	4 kV
Installation Category	300 Vrms cat. III
Standard	EN 50470
Ambient conditions and EMC	
According standards for indoor active energy meters.	
Temperature and climatic condition according to EN 62052-11	
Ambient conditions and Safety:	
According standards for indoor active energy meters.	
Temperature and climatic condition according to EN 62052-11	
Dust/water protection	IP20
Operation temperature	(-10 to 40) °C
Storage temperature	(-40 to 70) °C
Enclosure material	self extinguish, complying UL94 V
Indoor meter	Yes
Degree of pollution	2
AC voltage test	4 kV
Standard	EN 50470
Distance	up to 30 m indoors
Weight	150 g
Gross weight (packaging included)	170 g
Installation	DIN rail 35 mm
Dimensions (W x H x D)	36 mm x 90 mm x 64 mm
Package dimensions (W x H x D)	40 mm x 95 mm x 80 mm
Colour	RAL 7035

Smart Meter Accessories

IKA232-20/230 V

Ordering code: **030 046 833 000**

Module is accessory of Smart Meter. It is used for switching On or Off the electrical load up to 32 A.
Communication with Smart Meter: over terminals A1 on IKA232-20 and 5 on Smart Meter.



Voltage	230 V ± 10 %, 50/60 Hz
Current	32 A, 2 pole
Operation temperature	(-15 to 55) °C
Storage temperature	(-40 to 80) °C
Dust/water protection	IP20
Weight	130 g
Gross weight (packaging included)	135 g
Installation	DIN rail 35 mm
Dimensions (W x H x D)	17.5 mm x 85 mm x 60 mm
Package dimensions (W x H x D)	20 mm x 95 mm x 70 mm
Coil consumption	1.2 W

PACKAGE CONTAINS

1 module and 1 User Manual



BICOM432-40-WM1

Ordering code: **30.074.038**

Module is accessory of Smart Meter. It is used for switching On or Off the electrical load up to 32 A.
Communication with Smart Meter: optical (IR) communication port



Voltage	230 V ± 10 %, 50/60 Hz
Current	32 A, 4pole
Operation temperature	(-25 to 55) °C ((>55 to 70) °C at max. impulse duration which is 1 min)
Storage temperature	(-30 to 80) °C
Dust/water protection	IP20
Weight	250 g
Gross weight (packaging included)	270 g
Installation	DIN rail 35 mm
Dimensions (W x H x D)	35.2 mm x 90 mm x 60 mm
Package dimensions (W x H x D)	40 mm x 95 mm x 70 mm
Coil consumption	0.5 W

PACKAGE CONTAINS

1 module and 1 User manual





Weather Station

ORDERING CODE	Z-WAVE FREQUENCY	COUNTRY/REGION
ZMNHZD1	868.4 MHz	CEPT, China, Singapore, South Africa, UAE
ZMNHZD2	921.4 MHz	Australia, Brazil, New Zealand
ZMNHZD3	908.4 MHz	Chile, Mexico, USA/Canada
ZMNHZD4	869.0 MHz	Russia

Weather Station is used for measuring wind direction, wind velocity, wind gust, temperature, wind chill, rain rate, indoor/outdoor temperature and indoor/outdoor humidity. The four sensors measures 10 weather properties in total.

The Weather Station includes 4 sensors: two Thermo-Hygrometers (with LCD display), Anemometer (Wind Sensor) and Rain Sensor.



Wiring diagram

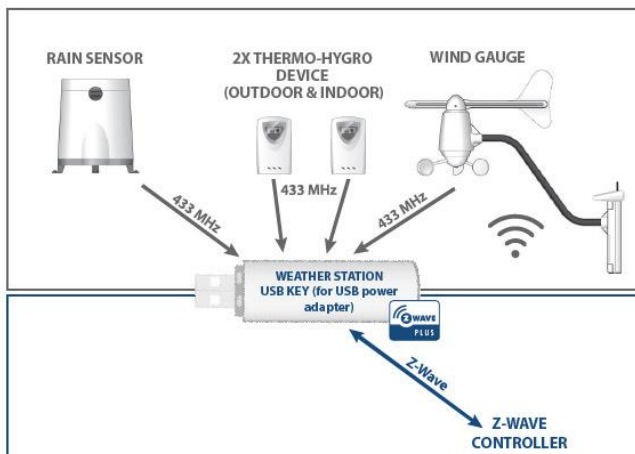

ADVANTAGES

- Sensors can measure **10 weather properties** in total
- **Wind gauge** measures **5 weather properties** and is powered by a solar panel
- Data received from the Weather Station can be used to trigger smart scenes in your smart home

TECHNICAL DATA

Weather Station	
Package dimensions (W x H x D)	460 mm x 120 mm x 430 mm
Weight (Gross with package)	0.8 kg (2 kg)
USB Key	
Power supply	USB Power Supply, 5 V DC
Operation temperature	(-10 to 40) °C
Distance to Z-Wave	up to 30 m indoors
Distance to 433MHz sensors	Up to 100 m
Dimensions (W x H x D)	79 mm x 16 mm x 24 mm
Electricity consumption	0.3 W
433 MHz Sensors	
Batteries	2x UM-3 or „AA“ size 1.5 V
Operation temperature	(-10 to 60) °C
Distance to USB Key	up to 100 m
Receiving cycle	Remote Thermo/Hygro -Sensors cca. 45 s Rain Gauge cca. 183 s Wind Sensor cca. 33 s
Temperature accuracy	± 1 °C or ± 2 °F
Humidity accuracy	± 5 %
Wind speed accuracy	± (2 mph + 5 %)
Wind direction accuracy	± 11.25°

PACKAGE CONTAINS

1 Rain Sensor, 2x Thermo-Hygro Sensors, 1 Wind Gauge, 1 Weather Station USB Key and 1 User manual



Flush On/Off Thermostat

ORDERING CODE	Z-WAVE FREQUENCY	COUNTRY/REGION
ZMNHID1	868.4 MHz	CEPT, China, Singapore, South Africa, UAE
ZMNHID2	921.4 MHz	Australia, Brazil, New Zealand
ZMNHID3	908.4 MHz	Chile, Mexico, USA/Canada
ZMNHID4	869.0 MHz	Russia

The Z-Wave module can be used to directly control an electrical or water floor heating system, electric water heater, hot water pump, electrical radiator, etc. As it is connected directly to either 230 V AC or 24 V DC, no batteries are required.

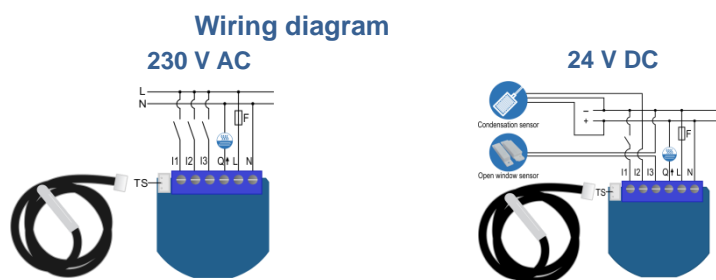

ADVANTAGES

Expanded temperature range: (-50.0 to 125.0) °C with a 0.1 °C resolution.

No batteries required - As it is connected directly to either 230 V AC or 24 V DC, no batteries are required.

Due to its small size the module can be easily installed inside a flush mounting box and covered with a traditional wall switch with two 1M blank covers.

The included temperature sensor comes with a **1 meter cable with connector** to connect the sensor directly to the relay module, no screwdriver is required.

Universal Thermostat – even for water boiler. The Z-Wave module can be used to directly control an electrical or water floor heating system, electric water heater, hot water pump, electrical radiator, etc.

Reduce heating costs - The module measures the power consumption of the connected electrical device to ensure your heating costs are under control.

TECHNICAL DATA

Power supply	(110 to 230) V AC \pm 10 % 50/60Hz, (24 to 30) V DC
Rated load current of AC output (resistive load)	1 X 10 A/230 V AC
Rated load current of DC output (resistive load)	1 X 10 A/30 V DC
Output circuit power of AC output (resistive load)	2300 W (230 V AC)
Output circuit power of DC output (resistive load)	240 W (24 V DC)
Power monitoring accuracy	P= (5 to 50) W, \pm 3 %; P>50 W, \pm 3 %
Frequency Range	868.4 MHz, 921.4 MHz, 908.4 MHz, 869.0 MHz, Z-Wave
Operation temperature	(-10 to 40) °C
Distance	up to 30 m indoors
Dimensions (W x H x D)	41.8 mm x 36.8 mm x 15.4 mm
Package dimensions (W x H x D)	115 mm x 96 mm x 22 mm
Weight	48 g
Gross weight (packaging included)	64 g
Electricity consumption	0.4 W
For installation in boxes	$\varnothing \geq$ 60 mm or 2M
Switching	Relay
Digital temperature sensor range	(-50.0 to 125.0) °C, resolution 0.1 °C
Digital temperature sensor cable length	1000 mm

Additional information is available in the technical specifications.

PACKAGE CONTAINS

1 module, 1 temperature sensor and 1 User manual



Flush Heat & Cool Thermostat

ORDERING CODE	Z-WAVE FREQUENCY	COUNTRY/REGION
ZMNHKD1	868.4 MHz	CEPT, China, Singapore, South Africa, UAE
ZMNHKD2	921.4 MHz	Australia, Brazil, New Zealand
ZMNHKD3	908.4 MHz	Chile, Mexico, USA/Canada
ZMNHKD4	869.0 MHz	Russia

Discrete Z-Wave Flush Heat & Cool Thermostat allows you to control 4 pipes fan coil or cooling beam with your smartphone.

Wiring diagram

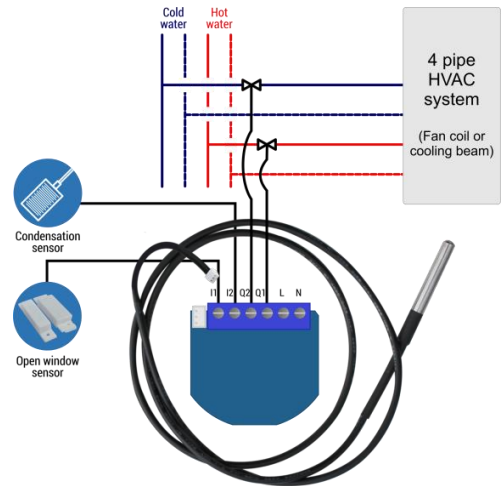
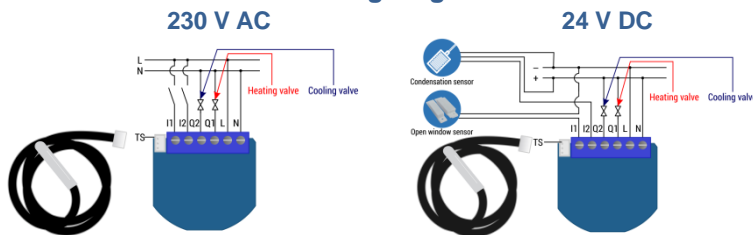

ADVANTAGES

Expanded temperature range: (-50.0°C to 125.0) °C with a 0.1 °C resolution.

No batteries required - As it is connected directly to either 230 V AC or 24 V DC, no batteries are required.

Due to its small size the module can be easily installed inside a flush mounting box and covered with a traditional wall switch with two 1M blank covers.

Condensation sensor - Any time there is condensation, the thermostat will close the cooling valve.

Energy saving by Open window sensor

If the Open window sensor detects the window is open, the thermostat will stop heating or cooling to prevent energy lose.

The included temperature sensor comes with a **1 meter cable with connector** to connect the sensor directly to the relay module, no screwdriver is required.

TECHNICAL DATA

Power supply	(110 to 230) V AC ± 10 % 50/60Hz, (24 to 30) V DC
Rated load current of AC output (resistive load)	2 X 4 A/230 V AC
Rated load current of DC output (resistive load)	2 X 4 A/30 V DC
Output circuit power of AC output (resistive load)	2 X 920 W (230 V AC)
Output circuit power of DC output (resistive load)	2 X 96 W (24 V DC)
Power monitoring accuracy	P=(0 to 200) W, ± 2 W; P>200 W, ± 3 %
Frequency Range	868.4 MHz, 921.4 MHz, 908.4 MHz, 869.0 MHz, Z-Wave
Operation temperature	(-10 to 40) °C
Distance	up to 30 m indoors
Dimensions (W x H x D)	41.8 mm x 36.8 mm x 16.9 mm
Package dimensions (W x H x D)	115 mm x 96 mm x 22 mm
Weight	48 g
Gross weight (packaging included)	64 g
Electricity consumption	0.4 W
For installation in boxes	∅ ≥ 60 mm or 2M
Switching	Relay
Digital temperature sensor range	(-50.0 to 125.0) °C, resolution 0.1 °C
Digital temperature sensor cable length	1000 mm

Additional information is available in the technical specifications.

PACKAGE CONTAINS

1 module, 1 temperature sensor and 1 User manual



Flush PWM Thermostat

ORDERING CODE	Z-WAVE FREQUENCY	COUNTRY/REGION
ZMNHLD1	868.4 MHz	CEPT, China, Singapore, South Africa, UAE
ZMNHLD2	921.4 MHz	Australia, Brazil, New Zealand
ZMNHLD3	908.4 MHz	Chile, Mexico, USA/Canada
ZMNHLD4	869.0 MHz	Russia

Discrete Z-Wave PWM thermostat to control Floor heating or radiator.

Wiring diagram

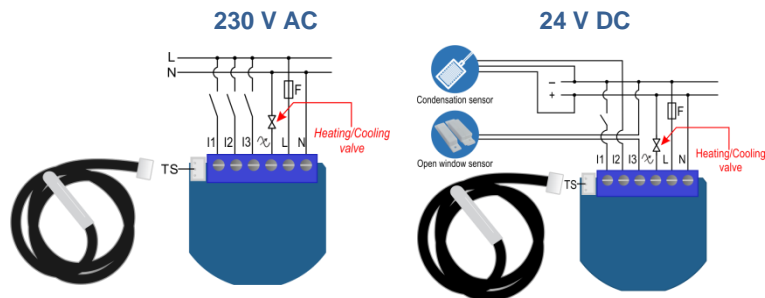

Thermal Actuator TWA-Z

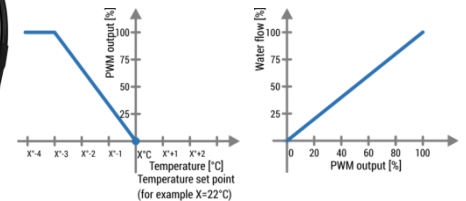
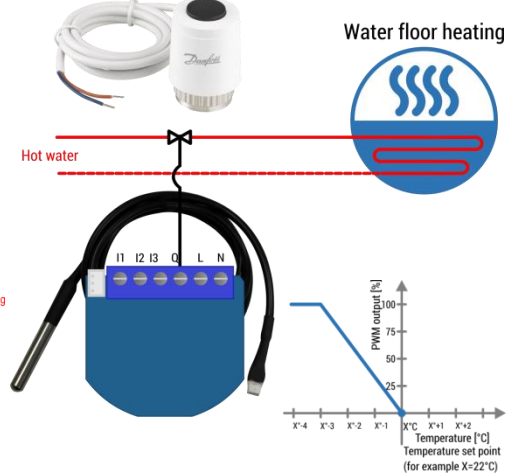

Left image: PWM output according to heating request
Right image: Water flow according to PWM output



ADVANTAGES

Linear valve control – stable temperature - Linear water flow control avoids temperature fluctuation

Expanded temperature range: (-50.0°C to 125.0) °C with a 0.1 °C resolution.

No batteries required - As it is connected directly to either 230 V AC or 24 V DC, no batteries are required.

Due to its small size the module can be easily installed inside a flush mounting box and covered with a traditional wall switch with two 1M blank covers.

Energy saving by Open window sensor - If the window is open, the thermostat will stop heating to prevent energy lose.

The included temperature sensor comes with a **1 meter cable with connector** to connect the sensor directly to the module, no screwdriver is required.

Works perfectly with Danfoss Thermal Actuator TWA-Z

TECHNICAL DATA

Power supply	(110 to 230) V AC \pm 10 % 50/60Hz, (24 to 30) V DC
Rated load current of AC output (resistive load)	0.85 A/230 V AC
Rated load current of DC output (resistive load)	0.85 A/30 V DC
Output circuit power of AC output (resistive load)	200 W (230 V AC)
Output circuit power of DC output (resistive load)	21 W (24 V DC)
Power monitoring accuracy	\pm 2 W
Frequency Range	868.4 MHz, 921.4 MHz, 908.4 MHz, 869.0 MHz, Z-Wave
Operation temperature	(-10 to 40) °C
Distance	up to 30 m indoors
Dimensions (W x H x D)	41.8 mm x 36.8 mm x 15.4 mm
Package dimensions (W x H x D)	115 mm x 96 mm x 22 mm
Weight	48 g
Gross weight (packaging included)	64 g
Electricity consumption	0.7 W
For installation in boxes	$\varnothing \geq$ 60 mm or 2M
Switching	MOSFET
Digital temperature sensor range	(-50.0 to 125.0) °C, resolution 0.1 °C
Digital temperature sensor cable length	1000 mm
Additional information is available in the technical specifications.	

PACKAGE CONTAINS

1 module, 1 temperature sensor and 1 User manual



Accessories List

Temperature Sensor

Ordering code: **ZMNHEA1**

Digital Temperature Sensor has 1 m cable with connector to connect directly to Qubino modules.

Digital temperature Sensor range	(-50.0 to 125.0) °C
Cable lenght	1000 mm
Package dimensions (W x H x D)	140 mm x 170 mm x 80 mm
Gross weight (packaging included)	20 g



Temperature Sensor

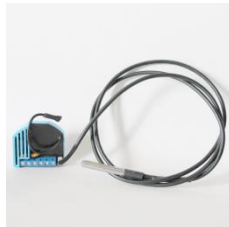

Temperature Sensor connection to the module



Installation of the Temperature Sensor inside the 2M casing SET



Installation of the Temperature Sensor inside the Wall Mounted Casing

PACKAGE CONTAINS

1 Temperature Sensor and 1 User manual



2M Casing SET

Ordering code: **ZMNHFA1**

Temperature Sensor can be installed behind 2M Casing SET. SET is suitable for mounting on boxes Ø60 with claws. SET consists of:

- 1 X mounting frame 2M with claws,
- 2 X 1M perforated blank cover,
- 1 X cover plate

Material	PC/ABS
Dimensions	2M
Package dimensions (W x H x D)	80 mm x 80 mm x 35 mm
Gross weight (packaging included)	44 g

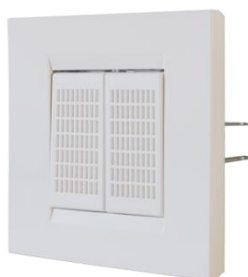

2M Casing SET

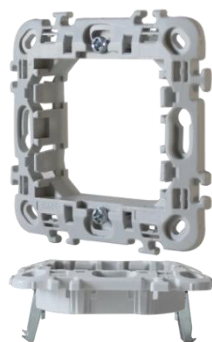

Mounting frame with claws



2 X 1M perforated blank cover to fill empty space
Colour: Polar white



Cover plate 2M
Colour: Polar white

PACKAGE CONTAINS

1 2M Casing SET and 1 User manual



Accessories List

Wall Mounted Casing

Ordering code: **ZMNHGA1**

Temperature sensor can be installed inside Wall Mounted Casing.

Dimensions	71 mm x 71 mm x 27 mm
Colour	White
Material	ABS
Package dimensions (W x H x D)	105 mm x 75 mm x 28 mm
Gross weight (packaging included)	34 g

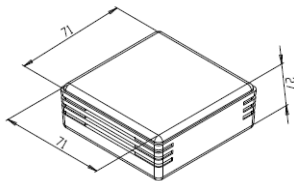

Wall Mounted Casing scheme



Installation of the Temperature Sensor inside the Wall Mounted Casing



Wall Mounted Casing front and side view

PACKAGE CONTAINS

1 Wall Mounted Casing and 1 User manual



Surface Door Densor

Ordering code: **NEDJAA1**

Sensor comes in three parts. Door mounted part is screwed by two screws on the door, the second part – Door frame part goes screwed on the door frame, this part has 2 connectors for 2 wires. Third part is called Cover for connectors and covers connectors.

When the door is closed the two parts should be aligned.

Material:	Anti-fire ABS shield
Connecting mode:	N.C.
Rated current:	300 mA
Rated voltage :	200 V DC
Operating distance:	More than 15 mm, less than 25 mm
Rated power:	3 W
Package dimensions (W x H x D):	85 mm x 94 mm x 22 mm
Gross weight (packaging included):	26 g



Surface Door Sensor

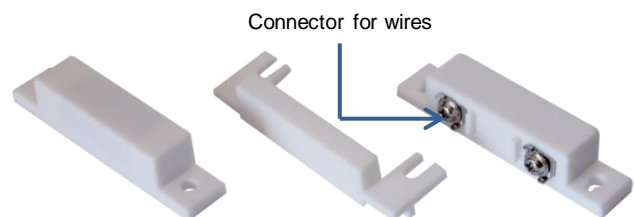

Connector for wires

Left part: Door mounted part
Middle part: Cover for connectors
Right part: Door frame part

PACKAGE CONTAINS

1 Wall Mounted Casing and 1 User manual



Accessories List

Built-in Door Sensor

Ordering code: **NEDJAA2**

Sensor comes in two parts. One part is built-in in the door, while the second part with 2 wires is inserted on the door frame.

When the door is closed the two parts should be aligned.

Material:	Anti-fire ABS shield
Connecting mode:	N.C.
Rated current:	100 mA
Rated voltage :	200 V DC
Operating distance:	More than 15 mm, less than 25 mm
Rated power:	2 W
Wires length:	150 mm
Package dimensions (W x H x D):	79 mm x 52 mm x 22 mm
Gross weight (packaging included):	12 g



Built-in Door Sensor

PACKAGE CONTAINS

1 Built-in Door Sensor and 1 User manual



Splicing Connector

Ordering code: **GEKDAA1**

COMPACT splicing connectors for all wire types; 5-conductor wire block; with operating levers; max. operating temperature 85 °C

Total number of connection points :	5
Rated voltage EN (1) [V]:	450 V
Nominal current [A]:	32 A
Solid sizes 1:	(0.2 to 4) mm ² /(24 to 12) AWG
Fine-stranded wires 1:	(0.14 to 4) mm ² /(24 to 12) AWG
Stranded, connectable 1.:	(0.2 to 4) mm ² /(24 to 12) AWG
Dimensions (W x H x D):	29.9 mm x 8.3 mm x 18.6 mm
Gross weight:	4.07 g

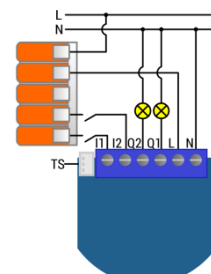
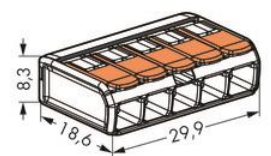

Example of connection

PACKAGE CONTAINS

1 Splicing Connector and 1 User manual



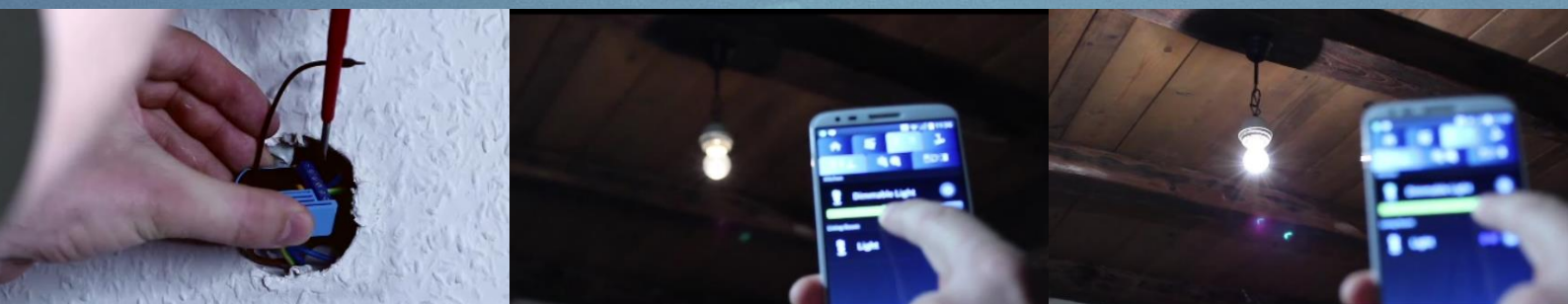

Goap d.o.o. Nova Gorica
007 Ulica Klementa Juga
Solkan 5250
Slovenia

E: info@qubino.com

W: www.qubino.com

P: +386 5 335 95 00

Document: Product catalogue_Qubino_V9.8
Catalogue is valid from 25/02/2016

 <https://www.facebook.com/QubinoModules>

 <https://www.youtube.com/channel/UC6Wq5o9qe9YX10chWkTo1Ug>

 <http://www.linkedin.com/company/qubino>

 <https://twitter.com/Qubino>